



INSTRUCTION MANUAL

UHF TRUNKED RADIO

IC-F43TR

(LTR®/Passport version)

This device complies with Part 15 of the FCC Rules.
Operation is subject to the condition that this device
does not cause harmful interference.

Icom Inc.



IMPORTANT

READ ALL INSTRUCTIONS carefully and completely before using the transceiver.

SAVE THIS INSTRUCTION MANUAL — This instruction manual contains important operating instructions for the **IC-F43TR UHF TRUNKED RADIO**.

EXPLICIT DEFINITIONS

WORD	DEFINITION
⚠ WARNING	Personal injury, fire hazard or electric shock may occur.
CAUTION	Equipment damage may occur.
NOTE	If disregarded, inconvenience only. No risk of personal injury, fire or electric shock.

Icom, Icom Inc. and the  ICOM logo are registered trademarks of Icom Incorporated (Japan) in the United States, the United Kingdom, Germany, France, Spain, Russia and/or other countries.

LTR® is a registered trademark of the E.F. Johnson Company.

All other products or brands are registered trademarks or trademarks of their respective holders.

PRECAUTIONS

⚠ CAUTION! NEVER hold the transceiver so that the antenna is very close to, or touching exposed parts of the body, especially the face or eyes, while transmitting. The transceiver will perform best if the microphone is 2 to 4 in. (5 to 10 cm) away from the lips and the transceiver is vertical.

⚠ CAUTION! NEVER operate the transceiver with a headset or other audio accessories at high volume levels.

⚠ CAUTION! NEVER short the terminals of the battery pack.

⚠ CAUTION! NEVER use non-Icom battery packs/chargers to prevent the loss of the transceiver's good performance and warranty.

DO NOT push PTT when not actually desiring to transmit.

DO NOT use or place the transceiver in direct sunlight or in areas with temperatures below +22°F (-30°C) or above +140°F (+60°C).

The basic operations, transmission and reception of the transceiver are guaranteed within the specified operating temperature range. However, the LCD display may not operate correctly, or show an indication in the case of long hours of operation, or after being placed in extremely cold areas.

FCC INFORMATION

DO NOT modify the transceiver for any reason.

KEEP the transceiver away from the heavy rain, and **Never** immerse it in the water. The transceiver construction is **water resistant***, not waterproof.

* Only when the supplied battery pack, flexible antenna and jack cover are attached.

Icom optional equipment is designed for optimal performance when used with this transceiver. We are not responsible for the transceiver being damaged or any accident caused when using non-Icom optional equipment.

For U.S.A. only

CAUTION: Changes or modifications to this transceiver, not expressly approved by Icom Inc., could void your authority to operate this transceiver under FCC regulations.

• FOR CLASS B UNINTENTIONAL RADIATORS:

This equipment has been tested and found to comply with the limits for a Class B digital device, pursuant to part 15 of the FCC Rules. These limits are designed to provide reasonable protection against harmful interference in a residential installation. This equipment generates, uses and can radiate radio frequency energy and, if not installed and used in accordance with the instructions, may cause harmful interference to radio communications. However, there is no guarantee that interference will not occur in a particular installation. If this equipment does cause harmful interference to radio or television reception, which can be determined by turning the equipment off and on, the user is encouraged to try to correct the interference by one or more of the following measures:

- Reorient or relocate the receiving antenna.
- Increase the separation between the equipment and receiver.
- Connect the equipment into an outlet on a circuit different from that to which the receiver is connected.
- Consult the dealer or an experienced radio/TV technician for help.

TABLE OF CONTENTS

IMPORTANT	i	6 CONVENTIONAL OPERATION.....	15–17
EXPLICIT DEFINITIONS.....	i	■ Receiving and transmitting	15
PRECAUTIONS.....	i	■ User set mode	16
FCC INFORMATION	ii	■ Emergency transmission	17
TABLE OF CONTENTS.....	iii	■ Scrambler function.....	17
1 ACCESSORIES	1–3	■ Stun function.....	17
■ Supplied accessories.....	1	■ Man Down transmission	17
■ Accessory attachments	1	7 OPTIONAL UNIT INSTALLATION.....	18–19
2 PANEL DESCRIPTION	4–8	■ UT-113 installation	18
■ Front panel.....	4	■ UT-108 installation	18
■ Function display.....	5	■ UT-109 and UT-110 installation.....	19
■ Programmable function keys	6	8 BATTERY CHARGING	20–22
3 BASIC OPERATION	9	■ Battery charging	20
■ Turning power ON.....	9	■ Battery caution.....	20
■ Channel selection	9	■ Optional battery chargers	21
■ Call procedure	9	9 SWIVEL BELT CLIP	23–24
4 PASSPORT OPERATION.....	10–12	■ MB-93 contents.....	23
■ Receiving a call.....	10	■ To attach	23
■ Transmitting a call	11	■ To detach	24
■ Other functions	12	10 OPTIONS	25
5 LTR OPERATION.....	13–14	11 SAFETY TRAINING INFORMATION	26–27
■ Receiving a call.....	13		
■ Transmitting a call	14		

■ Supplied accessories

The following accessories are supplied:	Qty.
① Flexible antenna.....	1
② Battery pack.....	1
③ Belt clip	1
④ Jack cover (with screws)	1 set

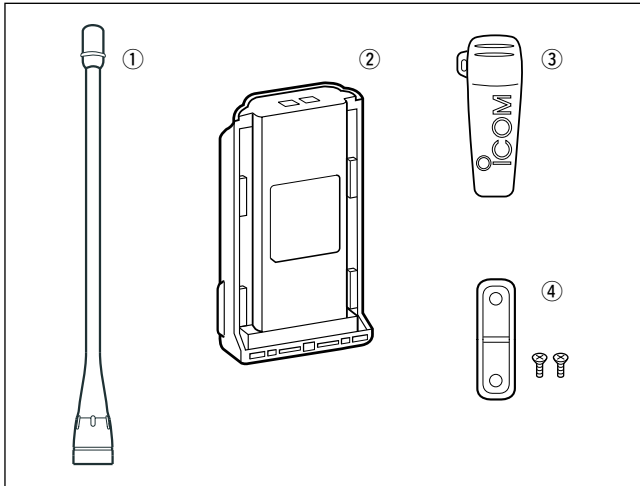

■ Accessory attachments

◇ Flexible antenna

Connect the supplied flexible antenna to the antenna connector.

CAUTION!

- **NEVER HOLD** the antenna when carrying the transceiver.
- Transmitting without an antenna may damage the transceiver.

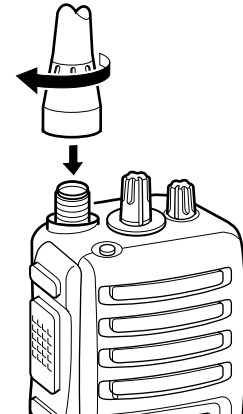

1 ACCESSORIES

◇ Battery pack

To attach the battery pack:

Slide the battery pack in the direction of the arrow (❶), then lock it with the battery release button.

- Slide the battery pack until the battery release button makes a 'click' sound.

To release the battery pack:

Push the battery release button in the direction of the arrow (❷) as shown below. The battery pack is then released.

NEVER release or attach the battery pack when the transceiver is wet or soiled. This may result water or dust getting into the transceiver/battery pack and may result in the transceiver being damaged.

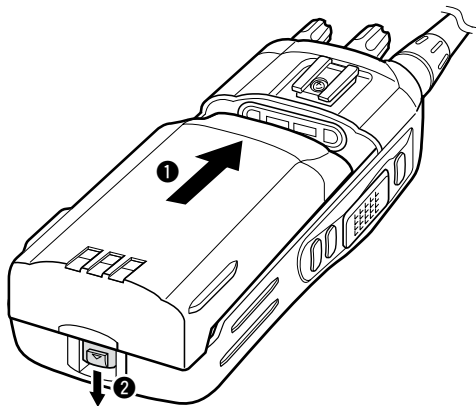

◇ Belt clip

To attach the belt clip:

- ❶ Release the battery pack if it is attached.
- ❷ Slide the belt clip in the direction of the arrow until the belt clip is locked and makes a 'click' sound.

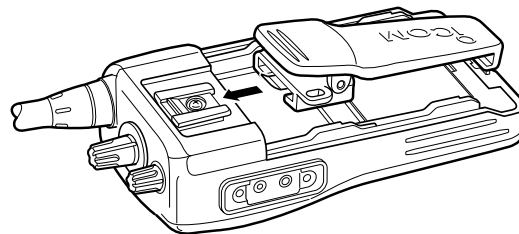

To detach the belt clip:

- ❶ Release the battery pack if it is attached.
- ❷ Lift the clip (❶), and slide the belt clip in the direction of the arrow (❷).

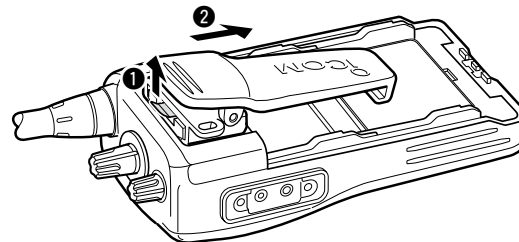

◇ Jack cover

Attach the jack cover when the optional speaker-microphone is not used.

To attach the jack cover:

- 1 Attach the jack cover on the [SP MIC] connector.
- 2 Tighten the screws.

To detach the jack cover:

- 1 Unscrew the screw with a Phillips screwdriver.
- 2 Detach the jack cover for the speaker-microphone connection.

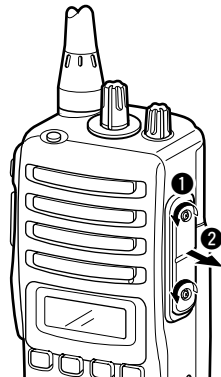
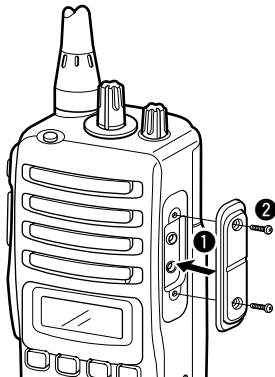

■ Front panel

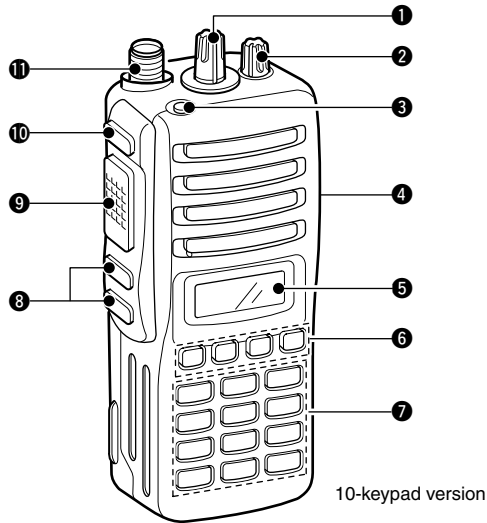

1 ROTARY SELECTOR

Selects the pre-programmed system channels or talk groups (Max. 16) on the LTR/Passport system. (Depending on the pre-setting)

2 VOLUME CONTROL [VOL]

Turns power ON and adjusts the audio level.

3 EMERGENCY KEY

Push to transmit the DTMF emergency call.

4 [SP]/[MIC] JACK

Connect the optional speaker-microphone.

- Attach the jack cover when the optional speaker-microphone is not used. (p. 3)

5 FUNCTION DISPLAY

Displays a variety of information such as operating channel name, DTMF encode channel, selected function, etc.

6 DEALER-PROGRAMMABLE KEYS [P0] to [P3]

Desired functions can be programmed independently by your dealer.

7 10-KEYPAD (Depending on version)

Used to enter DTMF encode channel, phone number, etc.

8 UP/DOWN [▲]/[▼] KEYS

➤ Push to select the operating channel.

➤ Push to select the talk group on the LTR or Passport system. (p. 8)

9 PTT SWITCH [PTT]

Push and hold to transmit; release to receive.

10 MONITOR KEY

Push to mute and release the CTCSS (DTCS) squelch mute. Open squelch/deactivate mute while pushing this key.

11 ANTENNA CONNECTOR

Connects the supplied antenna.

■ Function display

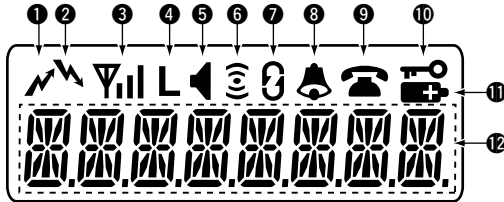

① TRANSMIT INDICATOR

Appears while transmitting.

② BUSY INDICATOR

Appears while the channel is busy.

③ SIGNAL STRENGTH INDICATOR

- Indicates relative signal strength level.
- Does not appear when the transceiver is out of the communication area on the PassPort system.

④ LOW POWER INDICATOR

- Appears when low output power is selected.
- When the battery power decreases to a specified level, low power is selected automatically.

⑤ MONITOR INDICATOR

Appears when the monitor key is pushed.

⑥ COMPANDER INDICATOR

Appears when the compander function is activated.

⑦ SCRAMBLER INDICATOR

Appears when the voice scrambler function is activated.

⑧ BELL INDICATOR

- Appears when the DTMF select call function is activated.
- Blinks when the DTMF select call is received.

⑨ PHONE INDICATOR

- Appears on the system channel/talk group in which a phone call is available.
- Blinks when the phone call is received.

⑩ KEY LOCK INDICATOR

Appears during the key lock function ON.

⑪ BATTERY INDICATOR

Appears or blinks when the battery power decreases to a specified level.

⑫ ALPHANUMERIC DISPLAY

Displays an operating channel name, DTMF encode channel, etc.

■ Programmable function keys

The following functions can be assigned to [P0], [P1], [P2], [P3], [Emergency], [Monitor], [*]* and [#]* programmable function keys.

Consult your Icom dealer or system operator for details concerning your transceivers programming.

If the programmable function names are bracketed in the following explanations, the specific key used to activate the function depends on programming.

*Available on 10-keypad version only.

SEND DTMF KEY

Push to enter the DTMF encode channel selection mode.

SELECT CALL KEY

- ➔ Push to turn the DTMF select call mute function ON.
- ➔ Push and hold to turn the DTMF select call mute function OFF.

PRIORITY KEY

Push to select the priority channel.

EMERGENCY KEY

Push to select the priority channel and automatically transmit a DTMF emergency call code.

SCAN A KEY

- ➔ This key's operation depends on the Power ON Scan setting.

When the power ON scan function is turned OFF;

Push to start and cancel scanning operation. In case of transmission during scan, cancels scanning.

When the power ON scan function is turned ON;

Push to pause scanning. Scanning resumes after passing a specified time period. In case of transmission during scan, pauses scanning. Scanning resumes after passing a specified time period specified.

- ➔ Push and hold this key for 1 sec. to indicate the scan group, then push to select the desired group.

SCAN B KEY

- ➔ Push to start and cancel scanning operation. In case of transmission during scan, pauses scanning. Scanning resumes after passing a specified time period.
- ➔ Push and hold this key for 1 sec. to indicate the scan group, then push to select the desired group.

PRIORITY CHANNEL KEYS

- ➔ Push to select Priority A or Priority B channel.
- ➔ Push and hold [**Prio A (Rewrite)**] to rewrite the Prio A channel.

MONITOR KEY

Push to mute and release the CTCSS (DTCS) squelch mute. Open squelch/deactivate mute while pushing this key.

NUISANCE DELETE KEY

Push to cancel the displayed channel from the scan list in the talk group.

SCAN TYPE KEY

Push to toggle the scan type from Individual or Block.

SPEED DIAL KEY

Push to send the most recently transmitted DTMF code selected with [**Send DTMF**].

TALK AROUND KEY

Turn the talk around function ON and OFF. This function equalizes the transmit frequency to the receive frequency for transceiver-to-transceiver communication.

WIDE/NARROW KEY

Push to toggle the IF passband width from “Wide” or “Narrow” channel spacing for both transmission and reception temporarily. Once the channel or bank has changed, the passband width returns to the original setting.

TX POWER KEY

Push to toggle the transmit output power level from the independent settings of each channel.

RE-DIAL KEY

Push to send the most recently transmitted DTMF code edited with 10-keypad.

RSSI KEY

Push to display the RSSI (Received Signal Strength Indicator) level.

MODE DISPLAY TYPE KEY

Push to toggle the scan mode display type from Individual and Block.

LOCK KEY

Push and hold for 2 sec. to turn the lock function ON and OFF.

PHONE REQUEST KEY

Push to turn the phone call function ON and OFF in the operating channel.

2 PANEL DESCRIPTION

ROAM REQUEST KEY

- ➔ Push to return to the home site.
- ➔ Push and hold to start roaming.

SITE LOCK KEY

Push to turn the Site Lock function ON and OFF.

This function inhibits automatic roaming, and can be useful when the transceiver is out of the communication area such as on a subway or in an elevator.

EMERGENCY SINGLE/REPEAT KEY

Push for the specified time period to select the emergency channel and automatically send a DTMF emergency signal once or repeatedly.

SCRAMBLER KEY

Push to toggle the scrambler function ON or OFF.

COMPANDER KEY

Push to turn the compander function ON and OFF.

The compander function reduces noise components from the transmitted audio to provide clear communication.

USER SET MODE KEY

Push for 1 sec. to enter the User set mode.

The User set mode allows you to set seldom-changed settings.

Push this key momentarily in the User set mode to select the function, and push **[CH Up]** or **[CH Down]** to change the setting.

SIREN KEY

Push to emit a siren. This function can be used for situations such as a security alarm for example.

SELECT MODE KEY (available for Passport/LTR only)

Push to select the operating mode from System or Talk Group.

• **System channel and talk group selection**

- ① Push **[Select Mode]** to select the operating mode from System or Talk Group.
- ② Then push **[UP]** or **[DOWN]** to select the desired system channel or talk group, in sequence.

■ Turning power ON

- ① Rotate [VOL] to turn the power ON.
- ② If the transceiver is programmed for a start up passcode, input the digit codes as directed by your dealer.
 - The keys in the table below can be used for password input:
 - The transceiver detects numbers in the same block as identical. Therefore "01234" and "56789" are the same.

KEY	P ₀	P ₁	P ₂	P ₃	UP
NUMBER	0	1	2	3	4
	5	6	7	8	9

- ③ When the "PASSWORD" indication does not clear after inputting 4 digits, the input code number may be incorrect. Turn the power off and start over in this case.

■ Channel selection

Push [UP] or [DOWN], or rotate [ROTARY SELECTOR] to select the desired system channel or talk group, in sequence.

- Up to 16 pre-programmed channels can be selected via [ROTARY SELECTOR].

■ Call procedure

When your system employs tone signalling (excluding CTCSS and DTCS), the call procedure may be necessary prior to voice transmission. The tone signalling employed may be a selective calling system which allows you to call specific station(s) only and prevent unwanted stations from contacting you.

- ① Select the desired DTMF encode channel according to your System Operator's instructions.
 - This may not be necessary depending on programming.
 - Refer to pgs. 11, 14, 16 for selection.
- ② Push the [PTT].
- ③ After transmitting a DTMF code, the remainder of your communication can be carried out in the normal fashion.

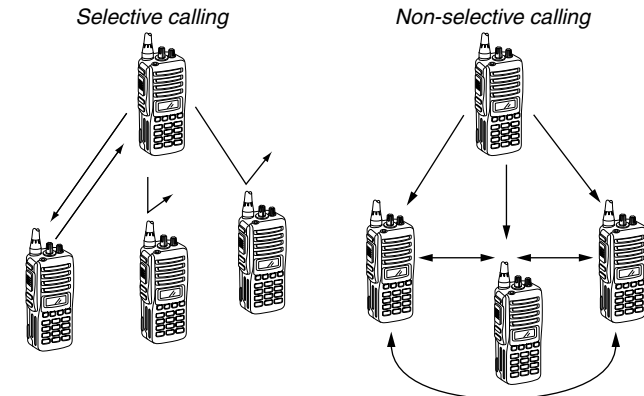

■ Receiving a call

◇ Group call

- ① Push [UP] or [DOWN], or rotate [ROTARY SELECTOR] to select the Passport system channel or talk group.
- ② When a call is received;
 - “↘” and the calling station name/ID appear.

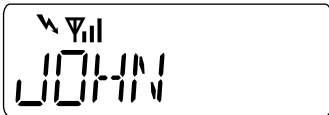

- ③ Push and hold [PTT], then speak into the microphone at a normal voice level.
- ④ Release [PTT] to return to receive.

◇ Individual call

- ① Push [UP] or [DOWN], or rotate [ROTARY SELECTOR] to select the Passport system channel or talk group.
- ② When a call is received;
 - “↘” and the calling station name/ID appear.

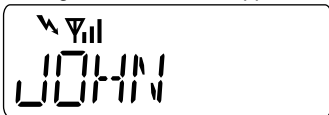

- ③ Push and hold [PTT], then speak into the microphone at a normal voice level.
- ④ Release [PTT] to return to receive.
- ⑤ To finish the conversation, push [DOWN] to send the “Clear Down” signal.

◇ Selective call (DTMF call)

—Optional UT-108 is required—

- ① Push [UP] or [DOWN], or rotate [ROTARY SELECTOR] to select the Passport system channel or talk group.
- ② Push [Select call] to mute the channel.
 - “🔔” appears.

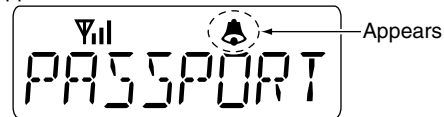

- ③ When receiving a call, the calling station name appears and a beep is emitted. Then the mute is released.
 - “🔔” disappears.

◇ Phone call

- ① Push [UP] or [DOWN], or rotate [ROTARY SELECTOR] to select the Passport system channel or talk group.
- ② When a phone call is received (transceiver rings), push and hold [PTT], then speak into the microphone at a normal voice level.
 - “📞” blinks and calling station name/ID appears for 1 sec.

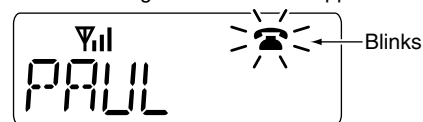

- ③ Release [PTT] to return to receive.
- ④ Push [#] while pushing [PTT] to finish the communication.

■ Transmitting a call

◇ Group call

- ① Push **[UP]** or **[DOWN]**, or rotate **[ROTARY SELECTOR]** to select the Passport system channel or talk group in which the group ID is pre-programmed.
- ② While pushing and holding **[PTT]**, speak into the microphone at a normal voice level after a beep is emitted.
 - If an error beep is emitted, release **[PTT]**. After a while, repeat step ② again.
 - The beep can be turned OFF in User set mode.
 - When the transceiver is out of the communication area, “**▽il**” disappears, and “NO SVC” message appears.

◇ Individual call

- ① Push **[UP]** or **[DOWN]**, or rotate **[ROTARY SELECTOR]** to select the Passport system channel or talk group in which the MID (Mobile ID) is pre-programmed.
- ② While pushing and holding **[PTT]**, speak into the microphone at a normal voice level after a beep is emitted.
 - If an error beep is emitted, release **[PTT]**. After a while, repeat step ② again.
 - The beep can be turned OFF in User set mode.
 - When the transceiver is out of the communication area, “**▽il**” disappears, and “NO SVC” message appears.
- ③ To finish the conversation, push **[DOWN]** to send the “Clear Down” signal.

◇ Selective call (DTMF call)

—Optional UT-108 is required—

- ① Push **[UP]** or **[DOWN]**, or rotate **[ROTARY SELECTOR]** to select the Passport system channel or talk group.
- ② Push **[Send DTMF]**— a DTMF encode channel appears.
- ③ Push **[UP]** or **[DOWN]** to select the desired DTMF encode channel.
- ④ Push **[PTT]** to transmit the selected DTMF code in the selected DTMF channel.
 - Push **[P0]** to cancel the DTMF transmission.

◇ Phone call (Available for 10-keypad version only)

- ① Push **[UP]** or **[DOWN]**, or rotate **[ROTARY SELECTOR]** to select the Passport system channel or talk group.
- ② Push **[Phone request]** to enable the phone call.
 - “☎” appears.

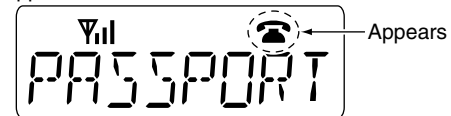

- ③ Push **[PTT]** to connect the phone line.
 - The proceed tone is emitted after connection to the phone line.
- ④ While pushing and holding **[PTT]**, enter the phone number via the 10-keypad to make the call. Then release **[PTT]**.
- ⑤ Push **[PTT]** to transmit; release to receive.
- ⑥ Push **[#]** while pushing **[PTT]** to finish the communication.

4 PASSPORT OPERATION

■ Other functions

◇ Manual roaming start function

If the transceiver has **[Roam Request]** assigned to it, you can start roaming manually to search for another site.

- ① Push **[UP]** or **[DOWN]**, or rotate **[ROTARY SELECTOR]** to select the Passport system channel or talk group.
- ② Push and hold **[Roam Request]** to start roaming.
 - “ROAMSITE” is displayed.
 - When “INVALID” is displayed, the home repeater may not have a neighbour site. After a while, repeat step ②.
- ③ Push **[Roam Request]** to cancel roaming.

◇ Site lock function

If the transceiver has **[Site Lock]** assigned to it, automatic roaming can be inhibited. This function is useful when the transceiver is out of the communication area such as on a subway or in an elevator.

- ① Push **[UP]** or **[DOWN]**, or rotate **[ROTARY SELECTOR]** to select the Passport system channel or talk group.
- ② Push **[Site Lock]** to turn the site lock function ON and OFF.
 - “SITELOCK” is displayed.

■ Receiving a call

◇ Group call

- ① Push **[UP]** or **[DOWN]**, or rotate **[ROTARY SELECTOR]** to select the LTR system channel or talk group.
- ② When a call is received;
 - “” and the calling station name/ID appear.





- ③ Push and hold **[PTT]**, then speak into the microphone at a normal voice level.
- ④ Release **[PTT]** to return to receive.

◇ Selective call (DTMF call)

—Optional UT-108 is required—

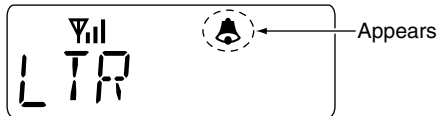
- ① Push **[UP]** or **[DOWN]**, or rotate **[ROTARY SELECTOR]** to select the LTR system channel or talk group.
- ② Push **[Select call]** to mute the channel.
 - “” appears.



- ③ When receiving a call, the calling station name appears and a beep is emitted. Then the mute is released.
 - “” disappears.

◇ Phone call

- ① Push **[UP]** or **[DOWN]**, or rotate **[ROTARY SELECTOR]** to select the LTR system channel or talk group.
- ② When a phone call is received (transceiver rings), push and hold **[PTT]**, then speak into the microphone at a normal voice level.
 - “” blinks and calling station name/ID appears for 1 sec.

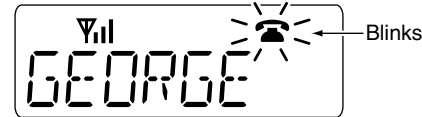

- ③ Release **[PTT]** to return to receive.
- ④ Push **[#]** while pushing **[PTT]** to finish the communication.

■ Transmitting a call

◇ Group call

- ① Push **[UP]** or **[DOWN]**, or rotate **[ROTARY SELECTOR]** to select the LTR system channel or talk group.
- ② While pushing and holding **[PTT]**, speak into the microphone at a normal voice level after a beep is emitted.
 - If an error beep is emitted, release **[PTT]**. After a while, repeat step ②.
 - The beep can be turned OFF in User set mode.

◇ Selective call (DTMF call)

—Optional UT-108 is required—

- ① Push **[UP]** or **[DOWN]**, or rotate **[ROTARY SELECTOR]** to select the LTR system channel or talk group.
- ② Push **[Send DTMF]**— a DTMF encode channel appears.
- ③ Push **[UP]** or **[DOWN]** to select the desired DTMF encode channel.
- ④ Push **[PTT]** to transmit the selected DTMF code in the selected DTMF channel.
 - Push **[Send DTMF]** to cancel the DTMF transmission.

■ Receiving and transmitting

/// **NOTE:** Transmitting without an antenna may damage the transceiver. See p. 1 for antenna attachment.

Receiving:

- ① Rotate **[VOL]** to turn the power ON.
- ② Push **[UP]** or **[DOWN]**, or rotate **[ROTARY SELECTOR]** to select the conventional system channel, in sequence.
- ③ When receiving a call, adjust the audio output level to a comfortable listening level.

Transmitting:

Wait for the channel to become clear to avoid interference.

- ① While pushing and holding **[PTT]**, speak into the microphone at a normal voice level.
- ② Release **[PTT]** to return to receive.

/// **IMPORTANT:** To maximize the readability of your signal;

1. Pause briefly after pushing **[PTT]**.
2. Hold the microphone 5 to 10 cm (2 to 4 inches) from your mouth, then speak into the microphone at a normal voice level.

◇ **Transmitting notes**

• **Transmit inhibit function**

The transceiver has several inhibit functions which restrict transmission under the following conditions:

- Channel is busy.
- Un-matched (or matched) CTCSS is received.
- The selected channel is a 'receive only' channel.

• **Time-out timer**

After continuous transmission for the pre-programmed time period, the time-out timer is activated, causing the transceiver to stop transmitting.

• **Penalty timer**

Once the time-out timer is activated, transmission is further inhibited for a period determined by the penalty timer.



6 CONVENTIONAL OPERATION

◇ DTMF receiving and transmitting

—Optional UT-108 is required—

If the transceiver has [Send DTMF] assigned to it, a DTMF encode channel is displayed when pushed, and assigned DTMF encode channels can be selected via [UP] or [DOWN].

Receiving:

- ① Push [UP] or [DOWN], or rotate [ROTARY SELECTOR] to select the conventional system channel, in sequence.
- ② Push [Select call] to mute the channel. (“” appears)
- ③ When receiving a call, a beep is emitted and mute is released. (“” disappears)

Transmitting:

- ① Push [UP] or [DOWN], or rotate [ROTARY SELECTOR] to select the conventional system channel, in sequence.
- ② Push [Send DTMF]— a DTMF encode channel appears.
- ③ Push [UP] or [DOWN] to select the desired DTMF encode channel.
- ④ Push [PTT] to transmit the selected DTMF code in the selected DTMF channel.
 - Push [P0] to cancel the DTMF transmission.

■ User set mode

User set mode is accessed with [User Set Mode] and allows you to set seldom-changed settings. In this case you can “customize” the transceiver operation to suit your preferences and operating style.

Entering the user set mode:

- ① Push and hold [User Set Mode] to enter user set mode. Push [User Set Mode] momentarily to select the item. Then push [UP] or [DOWN] to set the desired level/condition.

Available set mode functions:

- Backlight : ON, Auto or OFF
- Ringer : ON or OFF
- Beep : ON or OFF
- SQL Level : 0 to 255
- Mic Gain : 1 to 5
- Battery Voltage : ON or OFF
- System Information : ON or OFF
- Run-Time : The transceiver’s running time is displayed.

- ② Push and hold [User Set Mode] to exit user set mode.

■ Emergency transmission



When [**Emergency**], [**Emergency Single**] or [**Emergency Repeat**] is pushed, an emergency signal is automatically transmitted for the specified time period.

When [**Emergency**] is pushed, the DTMF emergency signal is transmitted on the priority channel.

When [**Emergency Single**] or [**Emergency Repeat**] is pushed for the specified time period, the DTMF emergency signal is transmitted once or repeatedly on the emergency channel. However, when no emergency channel is specified, the signal is transmitted on the previously selected channel.

■ Scrambler function

The voice scrambler function provides private communication between stations. The frequency inversion type is equipped to all versions, moreover, the optional Rolling or Non-rolling type can be available.

- ① Push [**Scrambler**] to turn the scrambler function ON.
 - “” appears.
- ② Push [**Scrambler**] again to turn the scrambler function OFF.
 - “” disappears.

■ Stun function

When the specified code, set as a stun code, is received, the stun function will be activated. When the stun code is received, “STUNNED” appears on the display and the transceiver cannot be used. To use the transceiver, the stun release code must be received.

Also, if the transceiver’s running time exceeds the preset running time limit, the transceiver cannot be used. To use the transceiver, extend the running time limit or turn the Run Time Limit function OFF using the CS-F43TR CLONING SOFTWARE.

■ Man Down transmission

When the optional UT-113 MAN DOWN UNIT is installed, the Man Down function can be used. The Man Down function transmits a man down emergency call after the specified time period has passed with the transceiver in a horizontal position.

■ UT-113 installation

Install the optional UT-113 MAN DOWN UNIT as follows:

- ① Rotate [VOL] to turn the power OFF, and remove the battery pack. (p. 2)
- ② Remove the unit cover.

NOTE: Use a flat head screw driver or a similar flat instrument, and insert into the hollow of the chassis, then lift and take away the unit cover. (The removed cover cannot be used again.)

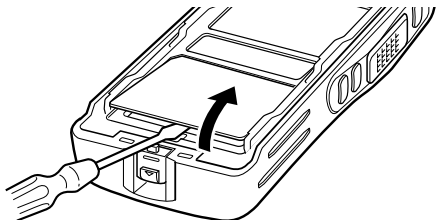

- ③ Install the unit as shown below.

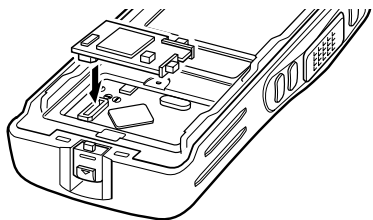

- ④ Replace the unit cover and the battery pack, then rotate [VOL] to turn the power ON.

■ UT-108 installation

Install the optional UT-108 DTMF DECODER UNIT as follows:

- ① Rotate [VOL] to turn the power OFF, and remove the battery pack. (p. 2)
- ② Remove the unit cover as shown at left.
- ③ Cut and solder the pattern on the PCB at the RX AF circuit as shown below.
- ④ Install the UT-108 DTMF DECODER UNIT the same way as described in the optional UT-113 installation as shown at left.
- ⑤ Replace the unit cover and the battery pack, then rotate [VOL] to turn the power ON.

NOTE: Be sure to un-solder A and B, and re-solder B and C, otherwise no AF output is available when you remove the DTMF decoder unit.

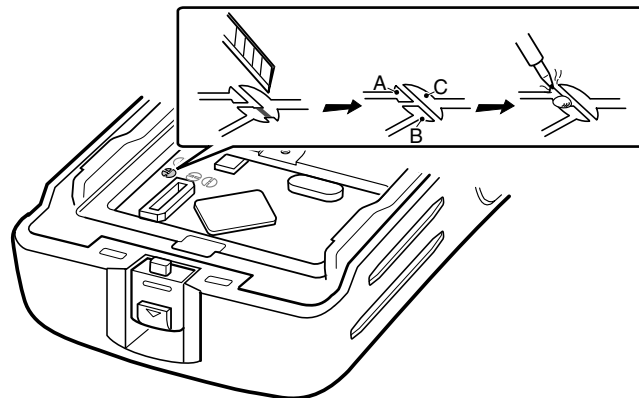

■ UT-109 and UT-110 installation

Install the optional UT-109/UT-110 SCRAMBLER UNITS as follows:

- ① Rotate [VOL] to turn the power OFF, and remove the battery pack. (p. 2)
- ② Remove the unit cover as shown on p. 18 (UT-113 installation).
- ③ Cut the pattern on the PCB at the TX mic circuit (MIC) and RX AF circuit (DISC) as shown below.
- ④ Install the UT-109/UT-110 SCRAMBLER UNITS as described in the optional UT-113 installation (p. 18).
- ⑤ Replace the unit cover and the battery pack, then rotate [VOL] to turn the power ON.

NOTE: Be sure to re-solder the disconnected points at left, otherwise no TX modulation or AF output is available when you remove the scrambler units.

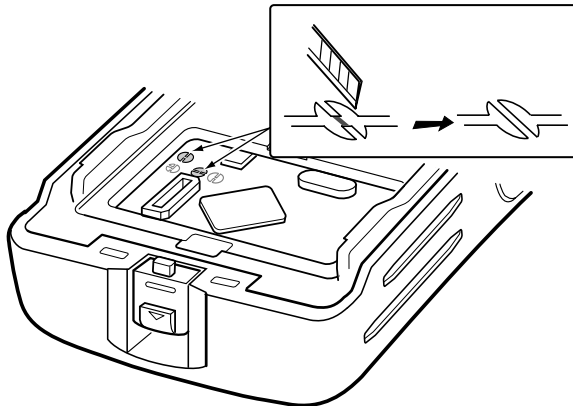
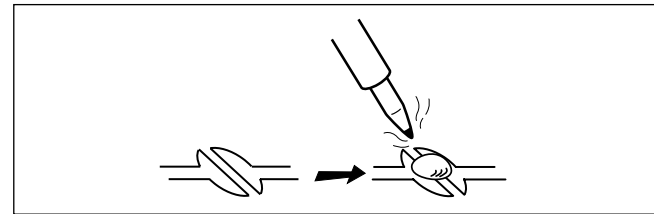

■ Battery charging

Prior to using the transceiver for the first time, the battery pack must be fully charged for optimum life and operation.

CAUTION: To avoid damage to the transceiver, turn the power OFF while charging.

- Recommended temperature range for charging: 0°C to +40°C (+32°F to +104°F)
- Use the specified chargers (BC-119N and BC-121N). **NEVER** use another manufacturer's charger.
- Use the specified AC adapter. **NEVER** use another manufacturer's adapter.

Recommendation:

Charge the supplied battery pack for a maximum of up to 10 hours. Li-Ion batteries are different from Ni-Cd batteries in that it is not necessary to completely charge and discharge them to prolong the battery life. Therefore, charging the battery in intervals, and not for extended periods is recommended.

■ Battery caution

CAUTION! NEVER insert battery pack/transceiver (with the battery pack attached) in a wet or soiled condition into the charger. This may result in corrosion of the charger terminals or damage to the charger. The charger is not waterproof and water can easily get into it.

NEVER incinerate used battery packs. Internal battery gas may cause an explosion.

NEVER immerse the battery pack in water. If the battery pack becomes wet, be sure to wipe it dry **BEFORE** attaching it to the transceiver.

NEVER short the terminals of the battery pack. Also, current may flow into nearby metal objects, such as a necklace, etc. Therefore, be careful when carrying with, or placing near metal objects, carrying in handbags, etc.

DO NOT leave the battery pack in a fully charged, or completely discharged condition for long time. It causes shorter battery life. In case of leaving the battery pack unused for a long time, it must be kept safely after discharge, or use the battery until the battery indicator appears, then remove it from the transceiver.

If your battery pack seems to have no capacity even after being charged, fully charge the battery pack again. If the batteries still do not retain a charge (or very little), new battery pack must be purchased.

■ Optional battery chargers

◇ AD-106 installation

The AD-106 CHARGER ADAPTER must be installed into the BC-119N or BC-121N before battery charging.

- Connect the AD-106 CHARGER ADAPTER and the BC-119N/BC-121N as below, then install the AD-106 into the holder space of the BC-119N or BC-121N with the supplied screws.

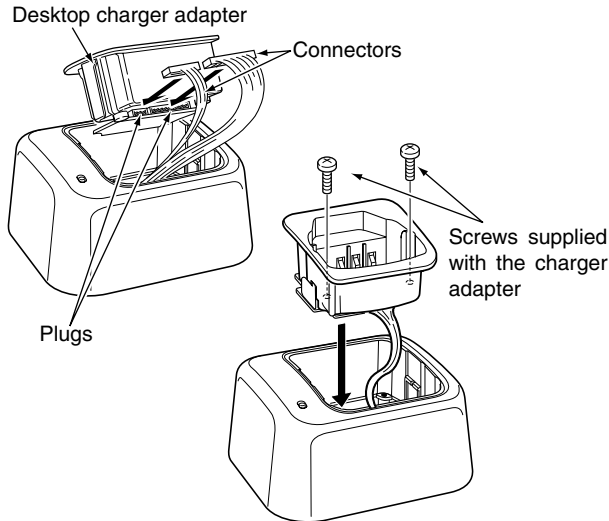

* This illustration is described with the BC-119N.

◇ Rapid charging with the BC-119N+AD-106

The optional BC-119N provides rapid charging of battery packs. The following are additionally required.

- AD-106 charger adapter
- An AC adapter (may be supplied with BC-119N depending on version).

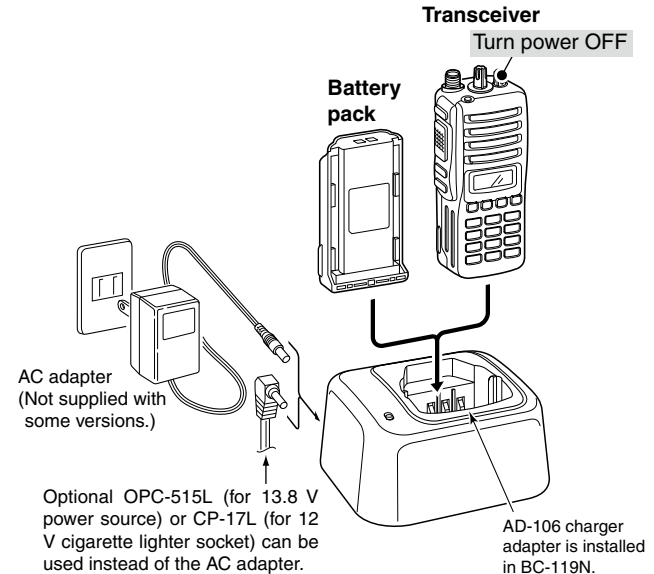

8 BATTERY CHARGING

◇ Rapid charging with the BC-121N+AD-106

The optional BC-121N allows up to 6 battery packs to be charged simultaneously. The following are additionally required.

- Six AD-106 charger adapters
- An AC adapter (BC-157)

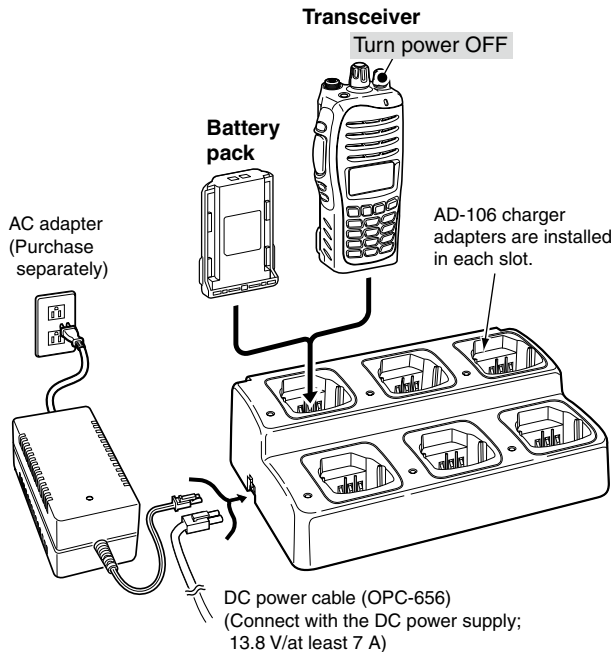

IMPORTANT: Ensure the sides of the battery pack are correctly aligned with the charger groves.

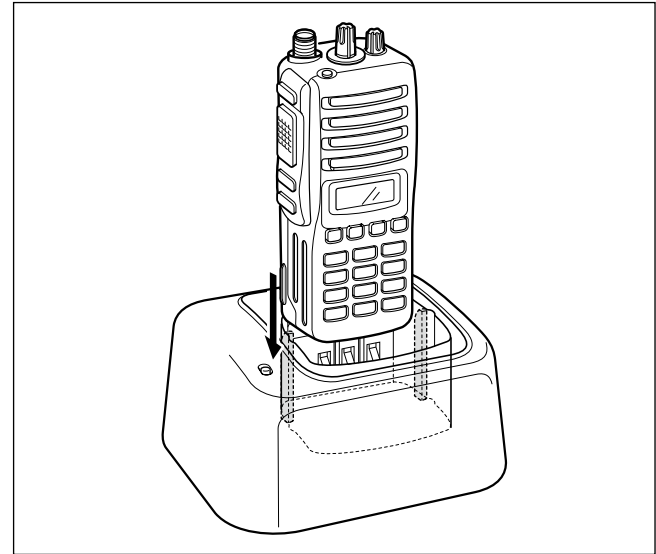

■ MB-93 contents

	Qty.
① Belt clip	1
② Base clip	1

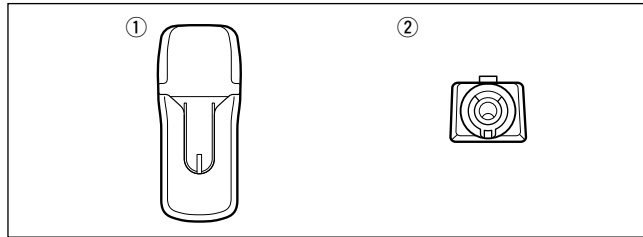

■ To attach

- ① Release the battery pack if it is attached. (p. 1)
- ② Slide the base clip in the direction of the arrow.

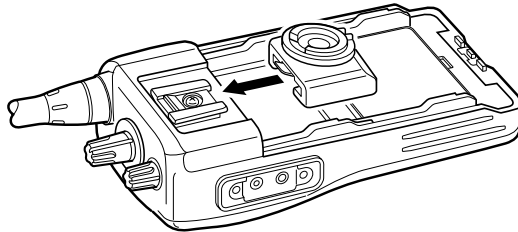

- ③ Clip the belt clip to a part of your belt. And insert the transceiver into the belt clip until the base clip inserted fully into the groove.

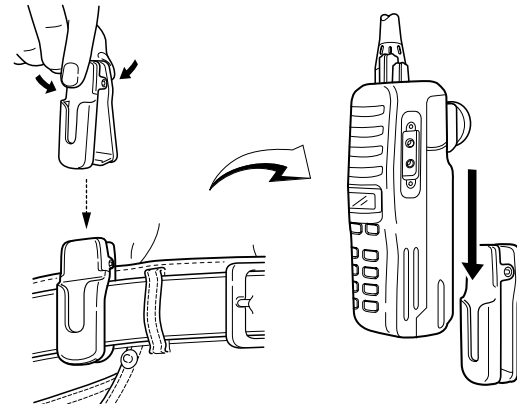

- ④ Once the transceiver is locked in place, it swivels as illustrated below.

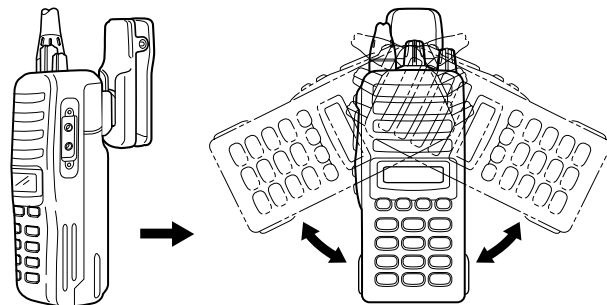

9 SWIVEL BELT CLIP

■ To detach

- ① Turn the transceiver upside down in the direction of the arrow and pull out from the belt clip.

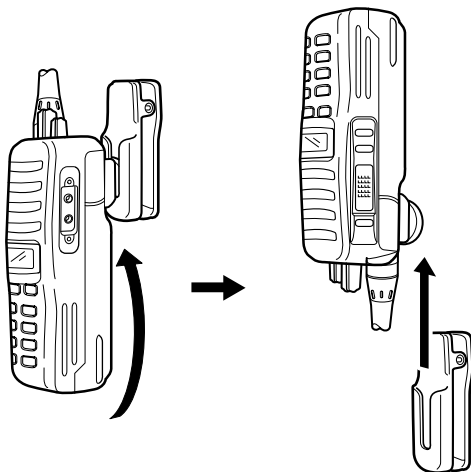

- ② Release the battery pack if it is attached. (p. 1)
- ③ Pinch the clip (①), and slide the base clip in the direction of the arrow (②).

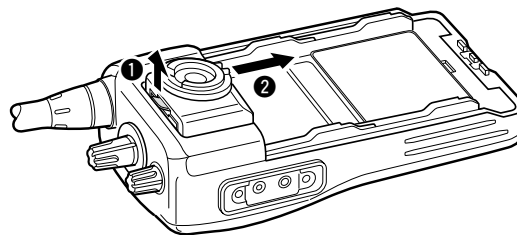

⚠ CAUTION!
HOLD THE TRANSCEIVER TIGHTLY, WHEN HANGING OR DETACHING THE TRANSCEIVER FROM THE BELT CLIP.

Otherwise the transceiver may not be attached to the holder or swivel properly if the transceiver is accidentally dropped and the base clip is scratched or damaged.

◇ BATTERY PACK

Battery packs	Voltage	Capacity	Battery life*1
BP-230N	7.4 V	980 mAh	7.3 hrs.
BP-232N	7.4 V	2000 mAh	15 hrs.
BP-240	Battery case for AAA (LR03) × 6 alkaline batteries		—*2

*1 Operating periods are calculated under the following conditions;
TX : RX : standby = 5 : 5 : 90

*2 Operating period depends on the alkaline cells used.

◇ CHARGERS

- **BC-119N** DESKTOP CHARGER + **AD-106** CHARGER ADAPTER
+ **BC-145** AC ADAPTER

For rapid charging of battery packs. An AC adapter is supplied with the charger depending on versions. Charging time: approx. 3 hours when BP-232 is attached.

- **BC-121N** MULTI-CHARGER + **AD-106** CHARGER ADAPTER (6 pcs.)
+ **BC-124** AC ADAPTER

For rapid charging of up to 6 battery packs (six AD-106's are required) simultaneously. An AC adapter should be purchased separately. Charging time: approx. 3 hours when BP-232 is attached.

◇ BELT CLIPS

- **MB-94** BELT CLIP
Exclusive alligator-type belt clip. The same as supplied with the transceiver.
- **MB-93** SWIVEL BELT CLIP
- **MB-96*/96F** LEATHER BELT HANGER

*MB-93's base clip is required.

◇ OPTIONAL UNITS

- **UT-108** DTMF DECODER UNIT
Provides pager and code squelch capabilities.
- **UT-109 (#02)/UT-110 (#02)** SCRAMBLER UNITS
Non-rolling type (UT-109)/Rolling type (UT-110) voice scrambler unit provides higher communication security.
- **UT-113** MAN DOWN UNIT
Provides a measure of safety when working in a hazardous environment, etc.

◇ DC CABLES

- **CP-17L** CIGARETTE LIGHTER CABLE
Allows charging of the battery pack through a 12 V cigarette lighter socket. (For BC-119N)
- **OPC-515L/OPC-656** DC POWER CABLES
Allows charging of the battery pack using a 13.8 V power source instead of the AC adapter.
OPC-515L: For BC-119N
OPC-656 : For BC-121N

◇ OTHER OPTIONS

- **SP-13** EARPHONE
Provides clear receive audio in noisy environment.
- **HM-46L/HM-131L** SPEAKER-MICROPHONES
Combination speaker-microphone that provides convenient operation while hanging the transceiver from your belt.
- **HS-94/HS-95/HS-97** HEADSET + **VS-1L** VOX/PTT CASE
HS-94: Ear-piece type
HS-95: Neck-arm type
HS-97: Throat microphone
VS-1L: VOX/PTT switch box for hands-free operation, etc.
- **FA-SC73US** STUBBY ANTENNA
Shorter UHF antenna. Frequency range: 450–490 MHz



Your Icom radio generates RF electromagnetic energy during transmit mode. This radio is designed for and classified as “Occupational Use Only”, meaning it must be used only during the course of employment by individuals aware of the hazards, and the ways to minimize such hazards.

This radio is NOT intended for use by the “General Population” in an uncontrolled environment.

This radio has been tested and complies with the FCC RF exposure limits for “Occupational Use Only”. In addition, your Icom radio complies with the following Standards and Guidelines with regard to RF energy and electromagnetic energy levels and evaluation of such levels for exposure to humans:

- FCC OET Bulletin 65 Edition 97-01 Supplement C, Evaluating Compliance with FCC Guidelines for Human Exposure to Radio Frequency Electromagnetic Fields.
- American National Standards Institute (C95.1-1992), IEEE Standard for Safety Levels with Respect to Human Exposure to Radio Frequency Electromagnetic Fields, 3 kHz to 300 GHz.
- American National Standards Institute (C95.3-1992), IEEE Recommended Practice for the Measurement of Potentially Hazardous Electromagnetic Fields— RF and Microwave.
- The following accessories are authorized for use with this product. Use of accessories other than those specified may result in RF exposure levels exceeding the FCC requirements for wireless RF exposure.; Belt Clip (MB-94), Rechargeable Li-Ion Battery Pack (BP-230N/BP-232N) and Speaker-microphone (HM-131L).

**CAUTION**

To ensure that your exposure to RF electromagnetic energy is within the FCC allowable limits for occupational use, always adhere to the following guidelines:

- **DO NOT** operate the radio without a proper antenna attached, as this may damage the radio and may also cause you to exceed FCC RF exposure limits. A proper antenna is the antenna supplied with this radio by the manufacturer or antenna specifically authorized by the manufacturer for use with this radio.
- **DO NOT** transmit for more than 50% of total radio use time (“50% duty cycle”). Transmitting more than 50% of the time can cause FCC RF exposure compliance requirements to be exceeded. The radio is transmitting when the TX indicator lights. You can cause the radio to transmit by pressing the “PTT” switch.
- **ALWAYS keep** the antenna at least 2.5 cm (1 inch) away from the body when transmitting and only use the Icom belt-clips listed on page 25 when attaching the radio to your belt, etc., to ensure FCC RF exposure compliance requirements are not exceeded. To provide the recipients of your transmission the best sound quality, hold the antenna at least 5 cm (2 inches) from your mouth, and slightly off to one side.

The information listed above provides the user with the information needed to make him or her aware of RF exposure, and what to do to assure that this radio operates with the FCC RF exposure limits of this radio.

Electromagnetic Interference/Compatibility

During transmissions, your Icom radio generates RF energy that can possibly cause interference with other devices or systems. To avoid such interference, turn off the radio in areas where signs are posted to do so. **DO NOT** operate the transmitter in areas that are sensitive to electromagnetic radiation such as hospitals, aircraft, and blasting sites.

Occupational/Controlled Use

The radio transmitter is used in situations in which persons are exposed as consequence of their employment provided those persons are fully aware of the potential for exposure and can exercise control over their exposure.

Count on us!

A-6344H-1EX-④
Printed in Japan
© 2004–2008 Icom Inc.

Printed on recycled paper with soy ink.

Icom Inc.

1-1-32 Kamiminami, Hirano-ku, Osaka 547-0003, Japan